

Pasternack

RF Product Guide 2019

Frequency Conversion
Components

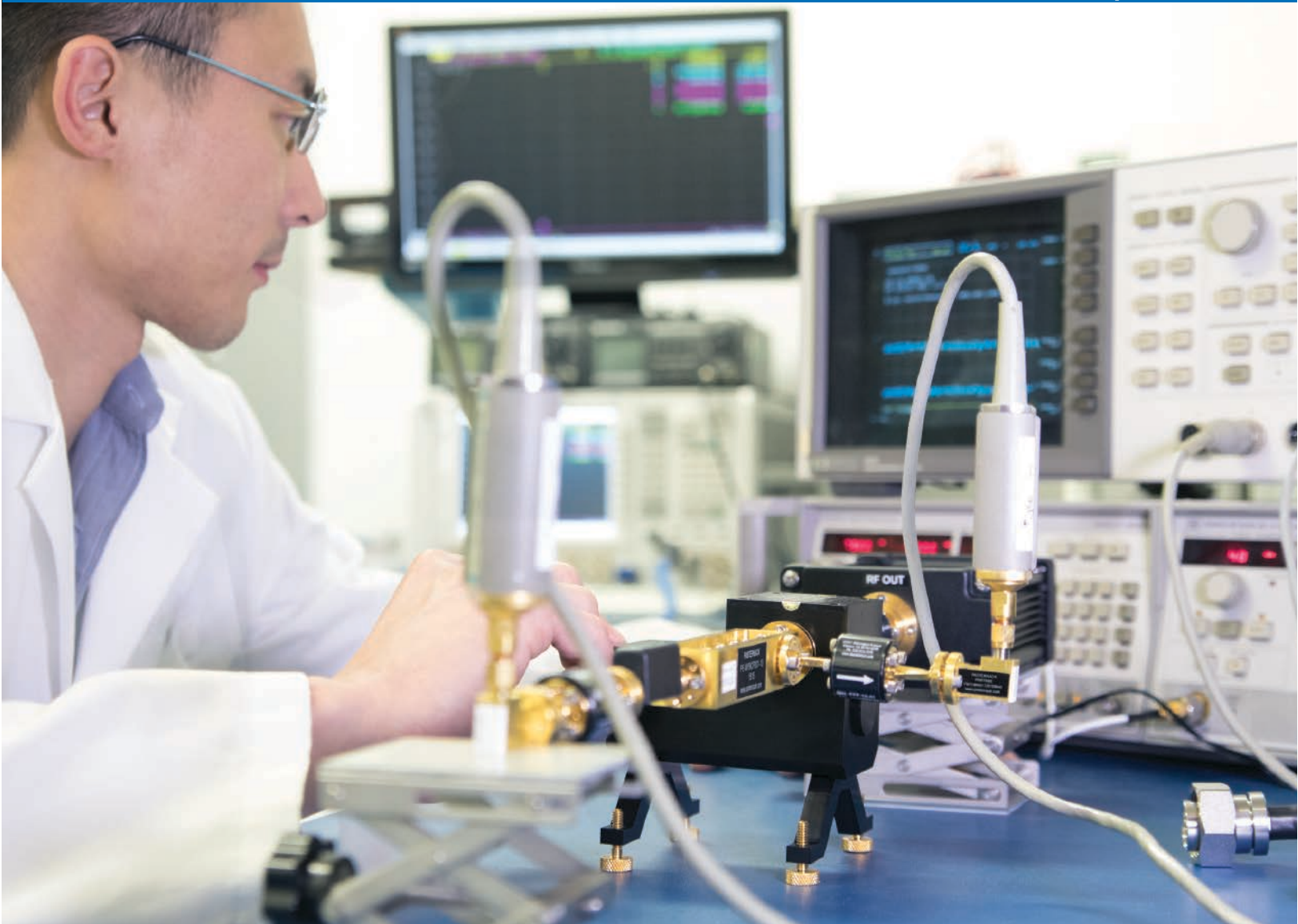

Largest Selection ✓ Same-Day Shipping ✓ Expert Technical Support ✓

866.727.8376 | sales@pasternack.com

PE PASTERNAK®
THE ENGINEER'S RF SOURCE

Lowpass Filters



Lowpass Filters

Bandpass Frequency (MHz)	Application	Rejection (MHz)	Max. Insertion Loss (dB)	Model No	1 Pc. Price	See Web for Volume Pricing			ROW
DC - 7,000		50 dB at 15,000	2	PE87FL1015	\$423.68				67
DC - 9,500		50 dB at 18,000		PE87FL1016	\$423.68				68
DC - 11,000				PE87FL1017	\$423.68				69

N Connectors

Band Pass



Bandpass Frequency (MHz)	Application	Rejection (MHz)	Max. Insertion Loss (dB)	Model No	1-24	25-49	50-99	100+	ROW
125 - 250				PE8728	\$2,150.69	\$2,000.14	\$1,849.59	\$1,720.55	70
250 - 500				PE8729	\$2,151.29	\$2,000.70	\$1,850.11	\$1,721.03	71
500 - 1 GHz				PE8730	\$2,300.38	\$2,139.35	\$1,978.33	\$1,840.30	72
750 - 1.5 GHz				PE8731	\$2,323.90	\$2,161.23	\$1,998.55	\$1,859.12	73
1 GHz - 2 GHz				PE8732	\$2,193.06	\$2,039.55	\$1,886.03	\$1,754.45	74
1.5 GHz - 3 GHz				PE8733	\$2,330.39	\$2,167.26	\$2,004.14	\$1,864.31	75

Band Reject



Bandpass Frequency (MHz)	Application	Rejection (MHz)	Max. Insertion Loss (dB)	Model No	1 Pc. Price	See Web for Volume Pricing			ROW
100 - 200				PE8734	\$2,385.58				76
200 - 400				PE8735	\$2,151.76				77
250 - 500				PE8736	\$2,604.79				78
1 GHz - 2 GHz				PE8738	\$2,300.38				79

FREQUENCY DIVIDERS



Frequency (GHz)	Divide-By Prescaler	CW Power In (dBm)	Max Power In (CW) (dBm)	Typ Power Out (dBm)	Output Transition Time (psec)	Connector	Model No	1	2-4	5-9	10+	ROW
0.5 - 8	5	-20		-1		SMA - SMA	PE88D5000	\$2,751.07	\$2,586.01	\$2,448.45	\$2,338.41	80
	2						PE88D2000	\$2,454.88	\$2,307.59	\$2,184.84	\$2,086.65	81
	4						PE88D4000	\$3,714.73	\$3,491.85	\$3,306.11	\$3,157.52	82
	8						PE88D8000	\$2,454.88	\$2,307.59	\$2,184.84	\$2,086.65	83
	10						PE88D1000	\$2,751.07	\$2,586.01	\$2,448.45	\$2,338.41	84

See Our Website For Current Pricing & Real-Time Stock Availability!

Filters

Frequency Conversion Components

MIXERS

Double Balanced

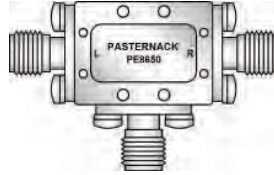

RF Range (GHz)	LO Range (GHz)	IF Range (GHz)	LO Power (dBm)	Conv. Loss (dB)	Connector	Model No	1	2-4	5-9	10+	ROW
2 - 8	2 - 8	DC - 1.5	10	5.5	SMA	PE8650	\$674.69	\$634.21	\$600.47	\$573.49	1
2 - 18	2 - 18	DC - 600 MHz	10	6.5	SMA	PE8652	\$874.80	\$822.31	\$778.57	\$743.58	2
2 - 18		1 - 6		7		PE86X1005	\$1,399.75	\$1,315.77	\$1,245.78	\$1,189.79	3
5 - 18	5 - 18	DC - 4	10	6.2	SMA	PE8653	\$961.92	\$904.20	\$856.11	\$817.63	4
5 - 20	5 - 20	DC - 3	20	10	SMA	PE86X1008	\$1,420.59	\$1,335.35	\$1,264.33	\$1,207.50	5
6 - 18	6 - 18	DC - 3	6	7.5	SMA	PE86X1007	\$1,476.18	\$1,387.61	\$1,313.80	\$1,254.75	6
7 - 14	7 - 14	DC - 5	13		SMA	PE86X1003	\$4,217.76	\$3,964.69	\$3,753.81	\$3,585.10	7
7 - 43	7 - 43	DC - 10	13	9	2.92mm	PE86X1009	\$2,677.94	\$2,517.26	\$2,383.37	\$2,276.25	8
11 - 20	11 - 20	DC - 6	13		2.92mm	PE86X1004	\$2,859.67	\$2,688.09	\$2,545.11	\$2,430.72	9
16 - 32	16 - 32	DC - 8	13		2.92mm	PE86X1000	\$3,274.30	\$3,077.84	\$2,914.13	\$2,783.16	10
23 - 37	23 - 37	DC - 13	13	9	2.92mm	PE86X1002	\$3,577.02	\$3,362.40	\$3,183.55	\$3,040.47	11
24 - 38	24 - 38	DC - 8	13	9	2.92mm	PE86X1001	\$3,274.30	\$3,077.84	\$2,914.13	\$2,783.16	12
24 - 40	24 - 40	DC - 18	13	8	2.92mm	PE86X1010	\$2,302.82	\$2,164.65	\$2,049.51	\$1,957.40	13

IQ

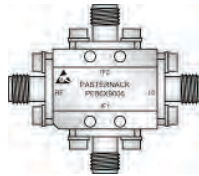

RF Range (GHz)	LO Range (GHz)	IF Range (GHz)	LO Power (dBm)	Conv. Loss (dB)	Connector	Model No	1	2-4	5-9	10+	ROW
4 - 8.5	4 - 8.5	DC - 3.5	15		SMA	PE86X9000	\$2,997.87	\$2,818.00	\$2,668.10	\$2,548.19	16
6 - 10	6 - 10	DC - 3.5	19	7.5	SMA	PE86X9001	\$2,997.87	\$2,818.00	\$2,668.10	\$2,548.19	17
8.5 - 13.5	8.5 - 13.5	DC - 2	19	8	SMA	PE86X9002	\$3,290.75	\$3,093.31	\$2,928.77	\$2,797.14	18
11 - 16	11 - 16	DC - 3.5	19	9	SMA	PE86X9003	\$3,596.78	\$3,380.97	\$3,201.13	\$3,057.26	19
15 - 23	15 - 23	DC - 3.5	17	8	SMA	PE86X9004	\$3,899.53	\$3,665.56	\$3,470.58	\$3,314.60	20
20 - 31	20 - 31	DC - 4.5	17	10	2.92mm	PE86X9005	\$4,674.11	\$4,393.66	\$4,159.96	\$3,972.99	21
30 - 38	30 - 38	DC - 3.5	17		2.92mm	PE86X9006	\$4,027.86	\$3,786.19	\$3,584.80	\$3,423.68	22

Triple Balanced

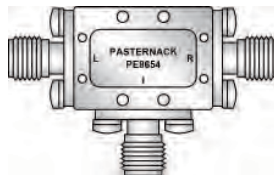

RF Range (GHz)	LO Range (GHz)	IF Range (GHz)	LO Power (dBm)	Conv. Loss (dB)	Connector	Model No	1	2-4	5-9	10+	ROW
2 - 8	2 - 8	100 MHz - 4	10	6.2	SMA	PE8651	\$825.27	\$775.75	\$734.49	\$701.48	14
6 - 18	6 - 18	1.5 - 8	10	7	SMA	PE8654	\$961.92	\$904.20	\$856.11	\$817.63	15

See Our Website For Current Pricing & Real-Time Stock Availability!

Frequency Conversion Components



Free Shipping Available via UPS Ground to USA & Canada



Technical Support (866) 727-8376



Same-Day Shipping, Even Custom Cable Assemblies

FREQUENCY MULTIPLIERS

Active

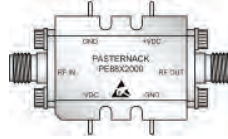

Input Freq. (GHz.)	Output Freq. (GHz.)	Input Drive Power (dBm)	Out Pwr Typ (dBm)	Fund. Iso. Typ (dB)	3rd Harmonics (dBc)	CW Pwr In (dBm)	Female In/Out Conn.	Model No	1	2-4	5-9	10+	ROW
4 - 10.5	8 - 21	6	14				SMA	PE88X2003	\$4,508.32	\$4,237.82	\$4,012.40	\$3,832.07	1
9 - 14.5	18 - 29		16				2.92mm	PE88X2000	\$3,767.90	\$3,541.83	\$3,353.43	\$3,202.72	2
12 - 16.5	24 - 33		17				PE88X2001	\$4,149.61	\$3,900.63	\$3,693.15	\$3,527.17	3	
16 - 23	32 - 46		13				PE88X2002	\$4,630.08	\$4,352.28	\$4,120.77	\$3,935.57	4	

*Field Replaceable Connectors

Standard



Input Freq. (GHz.)	Output Freq. (GHz.)	Input Drive Power (dBm)	Out Pwr Typ (dBm)	Fund. Iso. Typ (dB)	3rd Harmonics (dBc)	CW Pwr In (dBm)	Female In/Out Conn.	Model No	1	2-4	5-9	10+	ROW
1.5 - 5	3 - 10			25		13	SMA	PE8600	\$621.20	\$583.93	\$552.87	\$528.02	5
2 - 6	4 - 12							PE8601	\$693.06	\$651.48	\$616.82	\$589.10	6
4 - 9	8 - 18							PE8602	\$701.28	\$659.20	\$624.14	\$596.09	7
9 - 13	18 - 26							PE8603	\$701.35	\$659.27	\$624.20	\$596.15	8

*Field Replaceable Connectors

LIMITERS

Hi-REL

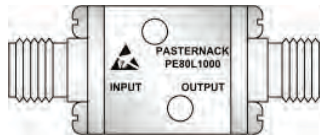

Frequency Range (MHz.)	Input Power Max. (dBm)	Insertion Loss (dB)	Recovery Time (ns)	Switching Speed (ns)	Return Loss (dB)	Model No	1	2-4	5-9	10+	ROW
500-18,000	1	1.5	10			PE80L1000	\$3,831.98	\$3,640.38	\$3,487.10	\$3,333.82	9
2,000-8,000	5	1	40			PE80L1001	\$4,359.38	\$4,097.82	\$3,879.85	\$3,705.47	10
2,000-18,000	1	2	100			PE80L2001	\$3,775.71	\$3,586.92	\$3,435.90	\$3,284.87	11
6,000-18,000	10	2.5	12			PE80L3000	\$4,544.24	\$4,317.03	\$4,135.26	\$3,953.49	12
12,000-18,000	1	1.5	10	PE80L2000	\$3,505.05	\$3,329.80	\$3,189.60	\$3,049.39	13		
18,000-40,000		4		PE80L4000	\$3,911.04	\$3,715.49	\$3,559.05	\$3,402.60	14		
				PE80L2002	\$4,858.35	\$4,566.85	\$4,323.93	\$4,129.60	15		

Frequency Range (MHz.)	Input Power Max. (dBm)	Insertion Loss (dB)	Recovery Time (ns)	Switching Speed (ns)	Return Loss (dB)	Model No	1	2-4	5-9	10+	ROW
20-4,000	2	0.8	15,000			PE80L2003	\$1,205.26	\$1,132.94	\$1,072.68	\$1,024.47	16
500-18,000	5	2				PE80L2005	\$1,674.16	\$1,573.71	\$1,490.00	\$1,423.04	17
2,000-18,000		2.5				PE80L2006	\$1,410.17	\$1,325.56	\$1,255.05	\$1,198.64	18

PASTERNAK ENTERPRISES -- REACH PRODUCT COMPLIANCE PROGRAM

What is REACH Compliance?

Regulation (EC) No. 1907/2006 of the European Parliament and of the Council of 18 December 2006 is commonly referred to as REACH (Registration, Evaluation, Authorization, and Restriction of Chemicals). The REACH regulation became effective on June 1, 2007 to streamline and improve the former legislative framework for chemicals available in the European Union (EU) and European Economic Area (EEA) countries.

The objective of REACH is to improve protection of human health and the protection of the environment from the exposure to chemicals. REACH compliance is mandatory for products manufactured in, or imported into the European Union (EU).

As outlined by the REACH regulation, any organization manufacturing, importing, using or placing a substance, mixture, article or product on the EU market will be responsible for ensuring that the component substances are in compliance with REACH regulations.

Determining REACH Compliance of Pasternack Products:

Pasternack Enterprises does not currently either manufacture or import any chemical substances into the EU on their own or in articles (products) in quantities of 1 ton or more per year. In addition, products imported by Pasternack Enterprises' customers do not contain chemical substances intended to be released during the normal and reasonably foreseeable conditions of the product's use as defined by the REACH regulation and existing guidance.

However, under REACH, there is an obligation to ensure that articles do not contain <0.1% by weight of Substances of Very High Concern (SVHCs). SVHCs are substances that may cause cancer or other serious health or environmental effects and thus face restriction or outright bans, and are listed in a regularly-updated 'Candidate list'. The current Candidate list can be downloaded from the European Chemicals Agency (ECHA) website:

http://echa.europa.eu/chem_data/authorisation_process/candidate_list_table_en.asp

For each part that has been found to comply with the REACH SVHC reporting requirements, we show an indication of compliance adjacent to the part number using this symbol:



All products displaying this symbol on our website are assured to contain no SVHCs as defined by the Candidate List displayed on the Pasternack REACH certificate. When you locate the product you need on our website, please click on the "Product ID or Part Number". You will see the "REACH symbol" for the specific part. Click on this symbol to view the Certificate of REACH Compliance (printable if needed) for the specific product as well as the applicable ECHA SVHC Candidate list Date.

Pasternack Enterprises - REACH Product Compliance Program:

At Pasternack Enterprises, we recognize our responsibility as a worldwide supplier of RF, Microwave and Fiber Optic Products subject to the REACH regulations. We have completed a comprehensive effort internally and with our supply chain to determine the REACH compliance of our products. You will find our Reach Symbol adjacent to all products on our website that have been determined by Pasternack and our supply chain to contain less than 0.1% by weight of the REACH substances. You will also see the applicable ECHA SVHC Candidate List Date. "Please refer to our website at www.Pasternack.com.

The Pasternack Enterprises REACH Product Compliance Program is implemented in accordance with Regulation No. 1907/2006 of the European Parliament and the Council of 18 December 2006. Pasternack has implemented a REACH compliance program to address this legislation. Pasternack Enterprises does not currently either manufacture or import any chemical substances into the EU on their own or in articles (products) in quantities of 1 ton or more per year. In addition, products imported by Pasternack Enterprises' customers do not contain chemical substances intended to be released during the normal and reasonably foreseeable conditions of the product's use as defined by the REACH regulation and existing guidance. Thus, Pasternack Enterprises does not currently have a direct REACH obligation to pre-register substances. Pasternack's REACH Product Compliance is determined by a certification from our supply chain. A Pasternack product is deemed to be REACH compliant when it does not contain Substances of Very High Concern (SVHCs) beyond the specified concentration limits of less than 0.1% by weight as outlined in REACH 1907/2006/EU regulation.

Need More Information?

If you have questions regarding REACH Product Certification on Pasternack's products, please contact the Pasternack REACH Compliance Team via email at REACH@Pasternack.com or by calling Toll-Free within North America at 1-866-PASTERNAK (1-866-727-8376). International customers, please call +1-949-261-1920.



Free Shipping Available
via UPS Ground
to USA & Canada



Technical
Support
(866) 727-8376



Same-Day Shipping,
Even Custom
Cable Assemblies

PASTERNAK ENTERPRISES ROHS COMPLIANCE PROGRAM

Lead-free solder is now available for all cable assemblies upon request or online at www.Pasternack.com.

Our Commitment

At Pasternack, we recognize our responsibility as an international supplier of RF, Microwave and Millimeter wave electronics products to maintain a comprehensive RoHS compliance program. We are fully committed to offering RoHS compliance on the majority of our products and posting accurate RoHS compliance status for all of our products. We have posted this data on our website so that it can be easily found for each part number within our on-line catalogue.

What is RoHS Compliance?

The European Union set forth the RoHS (Restriction of Hazardous Substances) Directive to establish environmental guidelines and legislation to reduce the presence of six (6) materials deemed hazardous to the environment. To comply, products entering the EU must not have a homogeneous presence of these materials above the following levels by weight percentage

- Lead (Pb) < 0.1%
- Mercury (Hg) < 0.1%
- Cadmium (Cd) < 0.01%
- Hexavalent Chromium (CrVI) < 0.1%
- Polybrominated Biphenyls (PBB) < 0.1%
- Polybrominated Diphenyl Esters (PBDE) < 0.1%

Determining Pasternack RoHS Compliance

All products displaying this symbol on our website have been certified as RoHS Compliant. Click on the symbol to view the Certificate of RoHS Compliance for that product.



Lead Free Cable Assemblies

Many of Pasternack's cable assemblies are built with leaded solder. If so, the part will not be RoHS compliant and a certificate will not be found on the product page for that assembly. However, many of these assemblies can be brought into RoHS compliance through the use of Lead-Free solder. If the assembly you desire is not RoHS compliant, there may be a RoHS compliant version with a similar part number. If so, you will see an "LF" contained in the basic part number (example PE3067LF-24 is the lead free version of PE3067-24). Please note: the "LF" designation is used only when the base part number is not RoHS compliant. Many assemblies do not include "LF" and are compliant because they are only offered in a RoHS compliant configuration.

For More Information

Please direct any questions to Pasternack Enterprises Technical Support via email at TechSupport@Pasternack.com or by calling Toll-Free within North America at 1-866-PASTERNAK (866-727-8376). International customers, please use +1-949-261-1920.

MAILING LIST CHANGES

If you receive more than one RF Product Guide with the same name and address, please notify Pasternack and pass the RF Product Guide along to a friend. Also, if you do not require multiple copies to the same company address, contact a sales representative to verify and modify your mailing information. A forms-based communications method to add, delete or modify mailing information is available at www.pasternack.com. By clicking "Contact Us", and then clicking "Remove Name from Mailing List", you may complete the form to request a change to your mailing preferences. In addition, by clicking "RF Product Guide", and then clicking "Request a Printed RF Product Guide", you may add your contact information to our mailing list. Please note service opt-in and opt-out options located on the forms. Alternatively, you may mail, email, telephone or fax Pasternack your request.

PLACING YOUR ORDER

► **By Telephone: 866-PASTERNAK (866-727-8376)
US & Canada, or 949-261-1920**

Our friendly sales representatives are ready to serve you from 5:00am to 5:30pm Pacific Standard Time (PST), Monday through Friday. For the most efficient service, please have ready a list of quantities and part numbers and, if paying by credit card, your MasterCard, VISA, American Express or Discover card. Note: Calls may be recorded or monitored for quality and training purposes.

► **By Fax: 949-261-7451**

Our fax lines can be accessed 7 days a week, 24 hours a day. Orders received after 4:00pm PST will be promptly processed and shipped the next business day. Please include your daytime phone number and/or email address in case we have any questions about your order.

► **By Internet: www.Pasternack.com
or Email: sales@pasternack.com**

Order online 7 days a week, 24 hours a day using our online ordering system. Just search for the items you want and add them to your shopping cart. Internet orders entered after 4:00 pm PST will be promptly processed and shipped the next business day.

► **By Mail: Simply Mail Your Order To:
Pasternack Enterprises, Inc.
17802 Fitch
PO Box 16759
Irvine, CA 92623-6759 USA**

International customers, please see "International Orders" below for additional information.

Terms and Conditions of Sale:

The following from Pasternack's Binding Terms and Conditions of Sale are provided for your convenience. A complete documentation of the Binding Terms and Conditions of Sale may be found in the back of the RF Product Guide, or on Pasternack's website at <http://www.pasternack.com/t-terms-of-sale.aspx>. Any questions or clarifications may be answered by contacting Customer Service at (+1) 949-261-1920 or by any of the methods listed above.

No Minimum Order Requirement

Ground Freight is Free:

On UPS Ground orders, there is no charge for shipping for USA & Canada orders of \$100.00 or greater. Otherwise, shipping or freight charges and insurance will be paid by the customer. All sales are made FOB Point (as defined by the INCOTERMS 2000) in Irvine, CA USA. Shipping or freight charges from Pasternack's Irvine, CA factory are prepaid and added to the invoice or billed collect.

Same-Day Shipment:

Same-day shipment will apply to orders received Monday through Friday, prior to 4:00pm PST.

- All UPS air and surface options
- All FedEx air options (with an approved account number)
- Most other shipping options, including DHL (with an approved account number) and USPS

Counter-to-Counter Shipping:

For your urgent order requiring our fastest shipping method, we will place your order on the next available flight from Santa Ana-Orange County John Wayne International Airport (Airport code: SNA) to the destination you specify. Please call for details.

Payment Terms:

Pasternack offers a number of convenient payment methods:

For United States customers, we offer check, money order, MasterCard, VISA, American Express, Discover, and C.O.D. as well as open account credit to qualified institutions and businesses. Payment must be made in US Dollars.

For Canadian customers, we offer all of the above payment options except C.O.D.

For International customers, see **International Orders**.

Open Account Credit:

Net 30 Days terms are available to businesses, schools and agencies subject to credit approval. Approval can begin by submitting a completed Credit Application, which can be found online at:

www.Pasternack.com/t-CreditApplication.aspx

EFT/Wire Transfers:

Please contact us for details. We will inform you of the total amount which will include shipping charges and any applicable wire transfer fees. Orders will not be accepted until funds have been received in full.

WELLS FARGO BANK
420 Montgomery St.
San Francisco, CA 94104 USA
Account Number: 4270 0000 0000 0000 1
Routing Number: 121000248
SWIFT Number: WFBUS6S

International Orders:

In addition to the United States and its territories, Pasternack accepts international orders. All orders of international origin are exported from the US in accordance with the Export Administration Regulations. Diversion contrary to US Law is prohibited. Please see Pasternack's Binding Terms and Conditions of Sale for full details.

Pasternack has international distributors for the following countries:

Africa: Namibia, South Africa

Asia-Pacific: Australia, China PRC, India, Indonesia, Japan, Malaysia, New Zealand, Singapore, South Korea, Thailand

Europe: Austria, Belgium, Czech Republic, Denmark, Finland, France, Germany, Ireland, Italy, Kazakhstan, Luxembourg, Netherlands, Norway, Poland, Portugal, Russia, Slovakia, Spain, Sweden, Switzerland, Turkey, United Kingdom

Middle East: Israel

South America: Brazil

To access their complete contact information, please see our International Distributors section in this RF Product Guide. (inside back cover)

International Shipping Charges:

Shipping or freight charges and insurance will be paid by the customer. All sales are made FOB Point (as defined by the INCOTERMS 2000) in Irvine, CA USA. We ship orders by UPS, FedEx (with an approved account number), or DHL (with approved account number) with delivery in 2 to 3 days to most locations worldwide.

International Taxes and Duties:

Customer is responsible for duties and taxes.



Free Shipping Available
via UPS Ground
to USA & Canada



Technical
Support
(866) 727-8376



Same-Day Shipping,
Even Custom
Cable Assemblies

BINDING TERMS AND CONDITIONS OF SALE

The following are the terms and conditions ("Terms and Conditions") for the sale of products ("Products") by Pasternack Enterprises, Inc. ("Pasternack") to Pasternack's customers ("Customers"). Please read this agreement carefully. Any different or additional terms set forth in customer's purchase order or similar communication are objected to and shall not be binding on the company unless a separate agreement has been signed by an authorized officer of the company. By placing an order for products from the company, or by accepting delivery of the products described on the applicable packing slip, bill of lading and/or invoice received with the products, you agree to be bound by and accept these terms and conditions of sale.

1. ACCEPTANCE AND CANCELLATION OF ORDERS

All orders are subject to acceptance by Pasternack in writing by a duly authorized agent of Pasternack; any written acknowledgement of receipt of an order shall not, in and of itself, constitute such acceptance. Orders accepted and processed by Pasternack may not be cancelled by Customer except as covered by the Limited Warranty. All sales are final. Cable Assemblies and Non-Standard Products are also Non-Cancelable/Non-Refundable ("NC/NR"). Non-Standard Parts are defined as Products which are special orders, custom orders, orders for non-standard products, products not customarily in stock or orders for value-added products. In the event of cancellation or other withdrawal of an order for any reason and without limiting any other remedy which Pasternack may have as a result of such cancellation or other withdrawal, reasonable cancellation or restocking charges, which shall include all expenses then incurred and commitments made by Pasternack, shall be paid by Customer to Pasternack. Customer requests to reschedule are subject to acceptance by Pasternack in its sole discretion. Orders may not be rescheduled after the order has been submitted by Pasternack to the shipment carrier.

2. PRICES

Orders are billed at the prices (in US dollars) in effect at the time of shipment. Prices will be as specified by Pasternack and will be applicable for the period specified in Pasternack's quote. If no period is specified, quoted prices will be applicable for thirty (30) days. The website contains the most current pricing and is the price reference for orders. Pricing included in the catalog is for reference only and final pricing is determined by the published website price. Prices shown in the RF Product Guide (Catalog) and on the website are subject to change without notice. Prices are exclusive of taxes, impositions and other charges, including: sales, use, excise, value added and similar taxes or charges imposed by any government authority, international shipping charges, forwarding agent's and broker's fees, bank fees, consular fees, document fees and import duties.

3. TERMS OF PAYMENT

All payments must be in US Dollars, or will be converted to US Dollars using the available exchange rate at the time of purchase.

MasterCard, VISA, Discover, and American Express credit cards, purchase cards and major bank debit cards are accepted. Payment via net thirty (30) days is available to businesses, schools and agencies or as otherwise specified by Pasternack subject to credit approval.

For International Orders

MasterCard, VISA, and American Express credit cards are accepted. Payment via open credit account with Net thirty (30) days may be established for companies having three U.S. references accepted to Pasternack. Prepaid Wire Transfer: You can wire the funds to our bank. We will contact you with the total amount, which will include shipping charges and a \$40 wire transfer fee. Orders will not be accepted until funds have been received in full and the Purchase Order (PO) has been received. Customer is responsible for sales, use, excise, value added and similar taxes or charges imposed by any government authority, international shipping charges, forwarding agent's and broker's fees, bank fees, consular fees, document fees and import duties.

4. SALES TAX

California residents are required to remit sales tax. Pasternack does not remit sales tax to states other than California. Any sales tax due that is not collected by Pasternack is the responsibility of the customer.

5. TOLERANCES

All coaxial cable assemblies displayed in the Pasternack catalog and website have a standard cable length tolerance of $\pm 1.5\%$ or 3/8 inches (0.375"), whichever is greater. Cable Assemblies in excess of this tolerance factor are eligible for repair and/or replacement under the terms of the Pasternack Limited Warranty.

6. DELIVERY AND TITLE

Shipping or freight charges and insurance will be paid by the customer. All sales are made FCA Shipping Point (as defined by the INCOTERMS 2000) in Irvine, CA USA. Shipping or freight charges from Pasternack's Irvine, CA facility are prepaid and added to the invoice, or billed collect. Subject to Pasternack's right of stoppage in transit, delivery of the Products to the carrier will constitute delivery to Customer and title and risk of loss will pass to Customer. Pasternack will make reasonable efforts to initiate shipment and schedule delivery as close as possible to Customer's requested delivery date(s). Customer acknowledges that delivery dates provided by Pasternack are estimates only and that Pasternack will not be liable for failure to deliver on such dates. Selection of the carrier and delivery route will be made by Pasternack unless specifically designated by Customer. Pasternack reserves the right to make deliveries in installments. Delay in delivery of one installment will not entitle Customer to cancel any other installment(s). Delivery of any installment of Products within thirty (30) days after the date requested will constitute a

timely delivery. Delivery of a quantity that varies from the quantity specified shall not relieve Customer of the obligation to accept delivery and pay for the Products delivered.

7. PASTERNAK'S LIMITED WARRANTY

All products are covered by a LIMITED WARRANTY for a period of one (1) year from the date of shipment when purchased from Pasternack Enterprises, Inc. Customer must notify Pasternack within one (1) year from date of shipment of any defective product. An approved Return Material Authorization (RMA) number must first be obtained from Pasternack prior to the return of any merchandise to Pasternack for inspection under warranty. Shipping charges for all materials returned under this Limited Warranty are to be prepaid by the Customer. This warranty is limited to the original purchaser. Pasternack's liability arising out of any sale of products to Customer is expressly limited to either (1) Credit for the purchase price paid by Customer for such products (without interest), or (2) Repair and/or replacement of such products, found to be defective after inspection by Pasternack, and such remedies shall be exclusive and in lieu of all others. THIS WARRANTY IS IN LIEU OF ANY AND ALL OTHER WARRANTIES, WHETHER ORAL, WRITTEN, EXPRESSED, IMPLIED OR STATUTORY. ANY IMPLIED WARRANTIES OF MERCHANTABILITY, FITNESS FOR A PARTICULAR PURPOSE AND NON-INFRINGEMENT ARE HEREBY DISCLAIMED. Further, no warranty will apply if the Product has been subject to misuse, neglect, accident or modification, or has been soldered or altered in any way.

All returns must be shipped to: Pasternack Enterprises, Inc.
17802 Fitch
Irvine, CA 92614 USA

8. LIMITATION OF LIABILITIES

In no event shall Pasternack be liable for any special, incidental or consequential damages of any nature including, but not limited to, damages resulting from loss of profit or revenue, recall costs, claims for service interruptions or failure to supply downtime, testing, installations or removal costs, costs of substitute products, property damage, personal injury, death or legal expenses. Customer's recovery from Pasternack for any claim shall not exceed the purchase price paid by Customer for the goods, irrespective of the nature of the claim, whether in warrant, contract or otherwise. CUSTOMER SHALL INDEMNIFY, DEFEND AND HOLD PASTERNAK HARMLESS FROM ANY CLAIMS brought by any party regarding products supplied by Pasternack and incorporated into the customer's product.

9. STATEMENTS AND ADVICE

If statements or advice, technical or otherwise, are offered or given to Customer, such statements or advice will be deemed to be given as an accommodation to Customer and without charge and Pasternack shall have no responsibility or liability for the content or use of such statements or advice.

10. EXPORT CONTROL AND EMBARGOES

Products purchased or received under these Terms and Conditions are subject to export control and economic sanctions laws, restrictions, regulations and orders of the United States. Customer agrees to comply with all applicable export control laws, restrictions and regulations of the United States and shall not export, or transfer for the purpose of re-export, any product to any embargoed country or region, including but not limited to Cuba, the Crimean Region of Ukraine, Iran, North Korea, Sudan, and Syria, or to any denied, blocked, or designated person or entity as mentioned in any such United States or foreign law or regulation. Customer represents and warrants that it is not on the Denied Persons, Specially Designated Nationals or Debarred Persons List (as identified by the U.S. Treasury Office of Foreign Asset Control (OFAC) and by the U.S. Department of Commerce, Bureau of Industry and Security (BIS), or any other United States list of prohibited persons; is not owned or controlled by any person that is on one of those lists, or is otherwise prohibited by United States or other law from purchasing the products or services hereunder. Customer shall be solely responsible to obtain any license to export, re-export or import as may be required. Customer also agrees that it will not use these products in connection with the proliferation of weapons of mass destruction, including missiles, nuclear, chemical or biological weapons.

11. GENERAL

The Terms and Conditions may not be modified or cancelled without Pasternack's written agreement. Accordingly, goods furnished and services rendered by Pasternack are sold only on the terms and conditions stated herein. The Terms and Conditions will be governed by and construed in accordance with the laws of the State of California and the applicable laws of the United States of America. If Customer chooses to access the Pasternack website from outside the United States, Customer does so on their own initiative and is responsible for compliance with all applicable local laws.

12. INTELLECTUAL PROPERTY

The drawings, text, product depictions, logos, content, product descriptions, and organization and taxonomy of Pasternack's RF Product Guide and website and of the described content within the RF Product Guide and website are proprietary to Pasternack and protected by intellectual property laws, including but not limited to United States Copyright law and United States Trademark law. Pasternack owns copyrights in these referenced works as well as the selection, arrangement, coordination and structure of the arranged content and works within their RF Product Guide and website. Use of the RF Product Guide/website does not give you any right to modify, reproduce, transmit, publish, publicly display, adapt, or create derivative works or in any way exploit any of the materials and content of Pasternack's RF Product Guide or website.

WARNING: Products in this catalog can expose you to chemicals including phthalates, which are known to the State of California to cause cancer and birth defects or other reproductive harm. For more information, go to www.P65Warnings.ca.gov. For specific products impacted, please visit www.pasternack.com.

50-OHM CONVERSION TABLE

(dBm - volts- watts)

dBm	V	Po
+53	100.0	200W
+50	70.7	100W
+49	64.0	80W
+48	58.0	64W
+47	50.0	50W
+46	44.5	40W
+45	40.0	32W
+44	32.5	25W
+43	32.0	20W
+42	28.0	16W
+41	26.2	12.5W
+40	22.5	10W
+39	20.0	8W
+38	18.0	6.4W
+37	16.0	5W
+36	14.1	4W
+35	12.5	3.2W
+34	11.5	2.5W
+33	10.0	2W
+32	9.0	1.6W
+31	8.0	1.25W
+30	7.10	1.0W
+29	6.40	800 mW
+28	5.80	640 mW
+27	5.00	500 mW
+26	4.45	400 mW
+25	4.00	320 mW
+24	3.55	250 mW
+23	3.20	200 mW
+22	2.80	160 mW
+21	2.52	125 mW
+20	2.25	100 mW
+19	2.00	80 mW
+18	1.80	64 mW
+17	1.60	50 mW
+16	1.41	40 mW
+15	1.25	32 mW
+14	1.15	25 mW
+13	1.00	20 mW
+12	0.90	16 mW
+11	0.80	12.5 mW
+10	0.71	10 mW
+9	0.64	8 mW
+8	0.58	6.4 mW
+7	0.50	5 mW
+6	0.45	4 mW
+5	0.40	3.2 mW
+4	0.36	2.5 mW
+3	0.32	2.0 mW

dBm	V	Po
+2	0.28	1.6 mW
+1	0.25	1.25 mW
0	0.23	1.0 mW
-1	0.20	.80 mW
-2	0.18	.64 mW
-3	0.16	.50 mW
-4	0.14	.40 mW
-5	0.13	.32 mW
-6	0.12	.25 mW
-7	0.10	.20 mW
-8	0.09	.16 mW
-9	0.08	.125 mW
-10	0.07	.10 mW
-11	0.06	
-12	0.06	
-13	0.05	
-14	0.05	
-15	0.04	
-16	0.0355	
dBm	mV	Po
-17	31.5	
-18	28.5	
-19	25.1	
-20	22.5	.01 mW
-21	20.0	
-22	17.9	
-23	15.9	
-24	14.1	
-25	12.8	
-26	11.5	
-27	10.0	
-28	8.9	
-29	8.0	
-30	7.1	.001 mW
-31	6.25	
-32	5.8	
-33	5.0	
-34	4.5	
-35	4.0	
-36	3.5	
-37	3.2	
-38	2.85	
-39	2.5	
-40	2.25	.1 µW
-41	2.0	
-42	1.8	
-43	1.6	
-44	1.4	
-45	1.25	

dBm	mV	Po
-46	1.18	
-47	1.0	
-48	0.9	
-49	0.8	
-50	0.71	.01 µW
-51	0.64	
-52	0.57	
-53	0.5	
-54	0.45	
-55	0.4	
-56	0.351	
-57	0.32	
-58	0.286	
-59	0.251	
-60	0.225	.001 µW
-61	0.2	
-62	0.18	
-63	0.16	
-64	0.141	
dBm	µV	Po
-65	128	
-66	115	
-67	100	
-68	90	
-69	80	
-70	71	.1 nW
-71	65	
-72	58	
-73	50	
-74	45	
-75	40	
-76	35	
-77	32	
-78	29	
-79	25	
-80	22.5	.01 nW
-81	20	
-82	18	
-83	16	
-84	11.1	
-85	12.9	
-86	11.5	
-87	10.0	
-88	9.0	
-89	8.0	
-90	7.1	.001 nW
-91	6.1	
-92	5.75	
-93	5.0	

dBm	µV	Po
-94	4.5	
-95	4.0	
-96	3.51	
-97	3.2	
-98	2.9	
-99	2.51	
-100	2.25	.1 pW
-101	2.0	
-102	1.8	
-103	1.6	
-104	1.41	
-105	1.27	
-106	1.18	
dBm	nV	Po
-107	1000	
-108	900	
-109	800	
-110	710	.01 pW
-109	640	
-112	580	
-113	500	
-114	450	
-115	400	
-116	355	
-117	825	
-118	285	
-119	251	
-120	225	.001 pW
-121	200	
-122	180	
-123	160	
-124	141	
-125	128	
-126	117	
-127	100	
-128	90	
-129	80	
-130	71	.1 fW
-131	61	
-132	58	
-133	50	
-134	45	
-135	40	
-136	35	
-137	33	
-138	29	
-139	25	
-140	23	.01 fW



Free Shipping Available
via UPS Ground to
USA & Canada



Technical
Support
(866) 727-8376



Same-Day Shipping,
Even Custom
Cable Assemblies

RETURN LOSS CONVERSION TABLE

Return Loss (dBm)	VSWR
46.064	1.01
40.086	1.02
36.607	1.03
34.151	1.04
32.256	1.05
30.714	1.06
29.417	1.07
28.299	1.08
27.318	1.09
26.444	1.10
25.658	1.11
24.943	1.12
24.289	1.13
23.686	1.14
23.127	1.15
22.607	1.16
22.120	1.17
21.664	1.18
21.234	1.19
20.828	1.20
20.443	1.21
20.079	1.22
19.732	1.23
19.401	1.24
19.085	1.25
18.783	1.26
18.493	1.27
18.216	1.28
17.949	1.29
17.690	1.30
17.445	1.31
17.207	1.32
16.977	1.33
16.755	1.34
16.540	1.35
16.332	1.36
16.131	1.37
15.936	1.38
15.747	1.39
15.563	1.40
15.385	1.41
15.211	1.42
15.043	1.43
14.879	1.44
14.719	1.45
14.564	1.46
14.412	1.47
14.264	1.48
14.120	1.49
13.979	1.50

Return Loss (dBm)	VSWR
13.842	1.51
13.708	1.52
13.577	1.53
13.449	1.54
13.324	1.55
13.201	1.56
13.081	1.57
12.964	1.58
12.849	1.59
12.736	1.60
12.625	1.61
12.518	1.62
12.412	1.63
12.308	1.64
12.207	1.65
12.107	1.66
12.009	1.67
11.913	1.68
11.818	1.69
11.725	1.70
11.634	1.71
11.545	1.72
11.457	1.73
11.370	1.74
11.285	1.75
11.202	1.76
11.120	1.77
11.039	1.78
10.960	1.79
10.881	1.80
10.804	1.81
10.729	1.82
10.654	1.83
10.581	1.84
10.509	1.85
10.437	1.86
10.367	1.87
10.298	1.88
10.230	1.89
10.163	1.90
10.097	1.91
10.032	1.92
9.968	1.93
9.904	1.94
9.842	1.95
9.780	1.96
9.720	1.97
9.660	1.98
9.601	1.99
9.542	2.00

Return Loss (dBm)	VSWR
9.485	2.01
9.428	2.02
9.372	2.03
9.317	2.04
9.262	2.05
9.208	2.06
9.155	2.07
9.103	2.08
9.051	2.09
8.999	2.10
8.949	2.11
8.899	2.12
8.849	2.13
8.800	2.14
8.752	2.15
8.705	2.16
8.657	2.17
8.611	2.18
8.565	2.19
8.519	2.20
8.474	2.21
8.430	2.22
8.386	2.23
8.342	2.24
8.299	2.25
8.257	2.26
8.215	2.27
8.173	2.28
8.138	2.29
8.091	2.30
8.051	2.31
8.011	2.32
7.972	2.33
7.933	2.34
7.894	2.35
7.856	2.36
7.818	2.37
7.781	2.38
7.744	2.39
7.707	2.40
7.671	2.41
7.635	2.42
7.599	2.43
7.564	2.44
7.529	2.45
7.494	2.46
7.460	2.47
7.426	2.48
7.393	2.49
7.360	2.50

Return Loss (dBm)	VSWR
7.327	2.51
7.294	2.52
7.262	2.53
7.230	2.54
7.198	2.55
7.167	2.56
7.135	2.57
7.105	2.58
7.074	2.59
7.044	2.60
7.014	2.61
6.984	2.62
6.954	2.63
6.925	2.64
6.896	2.65
6.867	2.66
6.839	2.67
6.811	2.68
6.783	2.69
6.755	2.70
6.728	2.71
6.700	2.72
6.673	2.73
6.646	2.74
6.620	2.75
6.594	2.76
6.567	2.77
6.541	2.78
6.516	2.79
6.490	2.80
6.465	2.81
6.440	2.82
6.415	2.83
6.390	2.84
6.366	2.85
6.341	2.86
6.317	2.87
6.293	2.88
6.270	2.89
6.246	2.90
6.223	2.91
6.200	2.92
6.177	2.93
6.154	2.94
6.131	2.95
6.109	2.96
6.086	2.97
6.064	2.98
6.042	2.99
6.021	3.00

Return Loss (dBm)	VSWR
5.999	3.01
5.970	3.02
5.956	3.03
5.935	3.04
5.914	3.05
5.893	3.06
5.872	3.07
5.852	3.08
5.832	3.09
5.811	3.10
5.791	3.11
5.771	3.12
5.751	3.13
5.732	3.14
5.712	3.15
5.693	3.16
5.674	3.17
5.654	3.18
5.635	3.19
5.617	3.20
5.598	3.21
5.579	3.22
5.561	3.23
5.542	3.24
5.524	3.25
5.506	3.26
5.488	3.27
5.470	3.28
5.452	3.29
5.435	3.30
5.417	3.31
5.400	3.32
5.383	3.33
5.365	3.34
5.348	3.35
5.331	3.36
5.315	3.37
5.298	3.38
5.281	3.39
5.265	3.40
5.248	3.41
5.232	3.42
5.216	3.43
5.200	3.44
5.184	3.45
5.168	3.46
5.152	3.47
5.137	3.48
5.121	3.49
5.105	3.50

MOUNTING HOLES

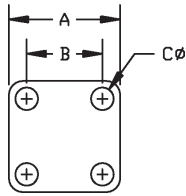

CODE	A	B	C
A01	.500	.340	.102
A02	.687	.500	.109
A03	.687	.500	#3-56 TAP
A04	.687	.500	.125
A05	1.000	.718	.125
A06	.750	.531	.140
A07	.750	.531	.125
A08	1.190	.906	.125
A09	.687	.500	#4-40 TAP
A10	.687	.500	.136
A11	1.250	.975	.147
A12	2.000	1.440	.257
A13	1.000	.718	.141
A14	1.000	.718	.144
A15	.687	.500	.104
A16	.750	.531	.136
A17	.375	.232	.067
A18	.625	.437	.094
A19	1.000	.718	#6-32 TAP
A20	.500	.340	#2-56 TAP
A21	1.250	.975	.142
A22	.375	.232	.093

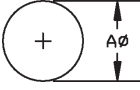

CODE	A
F01	.250
F02	.500
F03	.630
F04	1.200
F05	.380
F06	.450
F07	.200
F08	.362
F09	.220
F10	.317
F11	4.83mm
F12	.390

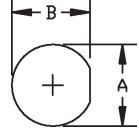

CODE	A	B
B01	.195	.177
B02	.250	.235
B03	.330	.295
B04	.380	.350
B05	.440	.410
B06	.512	.480
B07	.760	.720
B08	.565	.537
B09	.314	.296
B10	.140	.126
B11	.695	.655
B12	.625	.575
B13	.405	.361
B14	.277	.252
B15	.630	.596
B16	.317	.285
B17	.284	.268

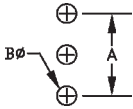

CODE	A	B
J01	.200	.046

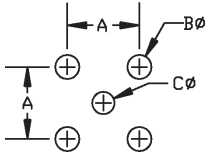

CODE	A	B	C
D01	.200	.067	.062
D02	.200	.067	.046
D03	.100	.031	.031
D04	.200	.052	.052
D05	.260	.067	.043
D06	.200	.052	.047
D07	.200	.055	.043
D08	.200	.067	.035
D09	.200	.055	.028
D10	.200	.055	.035
D11	.320	.091	.031
D12	.400	.062	.062
D13	.320	.091	.091
D14	.340	.091	.043
D15	.164	.067	.091
D16	.500	.126	.440
D17	.380	.083	.043

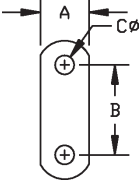

CODE	A	B	C
C01	.223	.481	.102
C02	.260	.481	.102
C03	.192	.328	.067
C04	.640	1.000	.125
C05	.275	.481	.102
C06	.230	.354	.067
C07	.188	.328	.093

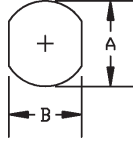

CODE	A	B
G01	.640	.546
G02	.380	.340
G03	.765	.712
G04	.362	.323
G05	.236	.197
G06	.217	.177
G07	.380	.310
G08	1.161	1.000

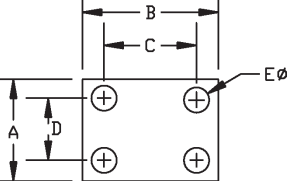

CODE	A	B	C	D	E
E01	.375	.500	.340	.222	.093

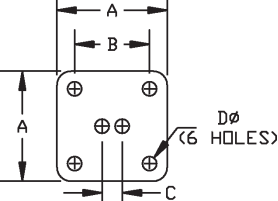

CODE	A	B	C	D
H01	.687	.500	.125	.045



Free Shipping Available
via UPS Ground to
USA & Canada



Technical
Support
(866) 727-8376



Same-Day Shipping,
Even Custom
Cable Assemblies

CONNECTOR IDENTIFIER

SPECIFICATIONS SHOWN ARE INTENDED FOR IDENTIFICATION PURPOSES ONLY











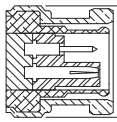
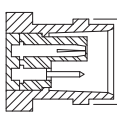
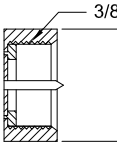
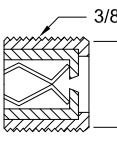
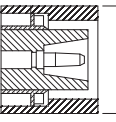
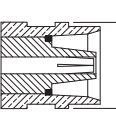
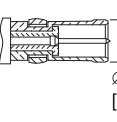
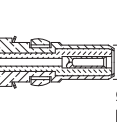
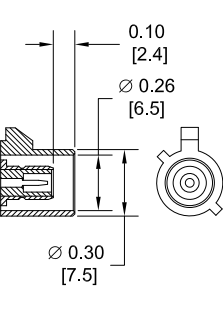
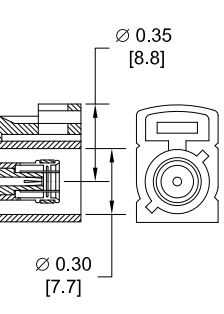





1.0/2.3 SLIDE ON	PLUG		1.0/2.3 SNAP ON	PLUG	 [4.8mm]	1.6/56	PLUG	 [10.8mm]
	JACK	 [4.1mm]		JACK	 [4.1mm]		JACK	 [8.3mm]
1.85 mm**	MALE	 HEX"/>	2.4 mm**	MALE	 HEX"/>	2.92 mm**	MALE	 HEX"/>
	FEMALE	 [5.8]"/>		FEMALE	 [5.3]"/>		FEMALE	 [5.3]"/>
3.5 mm*	MALE	 HEX"/>	7 mm	 [16.6]. Thread: 11/16-24. Hex length: 1-1/4\"/> HEX. Thread: M12 X 0.5F. Diameter: 0.87\"/> [22.1]"/>	7/16	PLUG	 HEX"/>	
	FEMALE	 [5.3]"/>		JACK		 [29.0]"/>		
3/4-20 TWINAX	MALE		10-32	MALE	 [6.4]"/>	BANANA	PLUG	 [8.3]. Diameter: 0.75\"/> [19.1]"/>
	FEMALE	 [15.6]"/>		FEMALE			JACK	 [11.0]. Diameter: 0.16\"/> [4.1]"/>
BNC	MALE	 [14.5]"/>	REVERSE POLARITY BNC	MALE	 [14.5]"/>	75 OHM BNC	MALE	 [14.5]"/>
	FEMALE	 [11.1]"/>		FEMALE	 [11.1]"/>		FEMALE	 [11.1]"/>

*SMA, 2.92mm, & 3.5mm CONNECTORS WILL MATE MECHANICALLY & ELECTRICALLY TO EACH OTHER.

**1.85mm & 2.4mm CONNECTORS WILL MATE MECHANICALLY & ELECTRICALLY TO EACH OTHER.

CONNECTOR IDENTIFIER

SPECIFICATIONS SHOWN ARE INTENDED FOR IDENTIFICATION PURPOSES ONLY

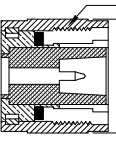
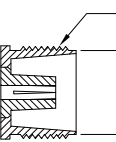
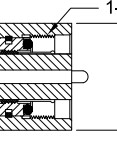
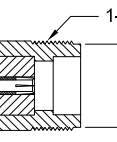
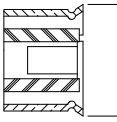
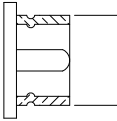
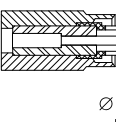
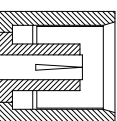
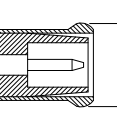
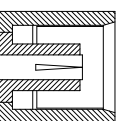
BNC TWINAX	PLUG	 Ø 0.57" [14.5mm]				
	JACK	 Ø 0.44" [11.1mm]				
F	MALE	 3/8-32 7/16 HEX				
	FEMALE	 3/8-32 Ø 0.34 [8.5]				
C	MALE	 Ø 0.75" [19.1mm]				
	FEMALE	 Ø 0.60" [15.2mm]				
D SUBMINIATURE	PLUG	 Ø 0.19" [4.8mm]				
	RECEPTACLE	 Ø 0.15" [3.9mm]				
FAKRA	PLUG	 0.10 [2.4] Ø 0.26 [6.5] Ø 0.30 [7.5]				
	JACK	 Ø 0.35 [8.8] Ø 0.30 [7.7]				
FAKRA	COMPLETE KEY CODE INFO	CODE	JACK	PLUG	COLOR	APPLICATION
		A			BLACK	RADIO WITH PHANTOM SUPPLY
		B			WHITE	RADIO WITHOUT PHANTOM SUPPLY
		C			BLUE	GPS: TELEMATICS OR NAVIGATION
		D			BORDEAUX	GSM: CELLULAR PHONE
H			VIOLET	GPS: TELEMATICS AND NAVIGATION		
I			BEIGE	BLUETOOTH		
K			CURRY	RADIO WITH I.F. OUTPUT (ANTENNA DIVERSITY)		
Z			WATER BLUE	NEUTRAL CODING		
GR874	MALE	 3/4-20 Ø 0.90 [22.9]				
	FEMALE	 3/4-20 Ø 0.67 [17.1]				
LC	MALE	 1-1/4-18 1-1/2 HEX				
	FEMALE	 1-1/4-18 Ø 1.17 [29.6]				
UMCX	PLUG	 Ø 0.10 [2.5]				
	JACK	 Ø 0.08 [2.0]				
MC-CARD	PLUG	 Ø 0.087 [2.2]				
	JACK	 Ø 0.20 [5.0]				
MCX	PLUG	 Ø 0.15 [3.7]				
	JACK	 Ø 0.20 [5.0]				

CONNECTOR IDENTIFIER

SPECIFICATIONS SHOWN ARE INTENDED FOR IDENTIFICATION PURPOSES ONLY

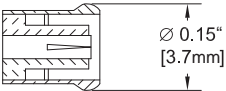
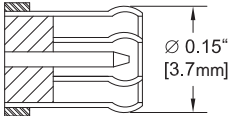
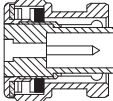
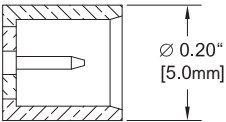
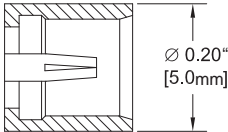
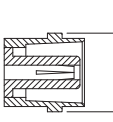
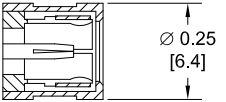
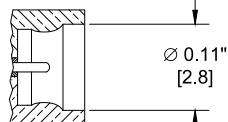
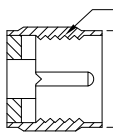
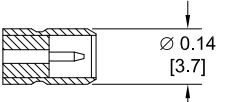
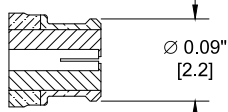
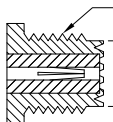
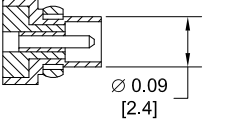
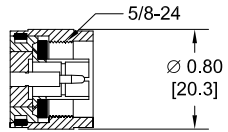
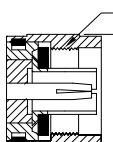
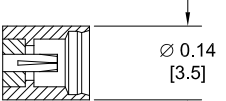
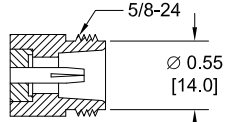
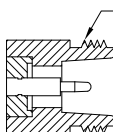
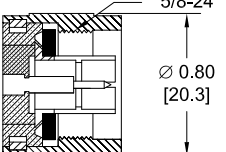
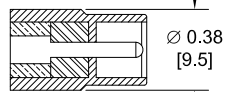
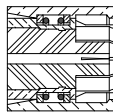
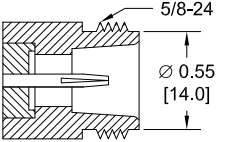
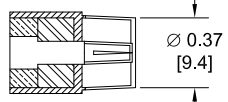
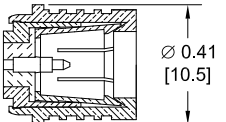
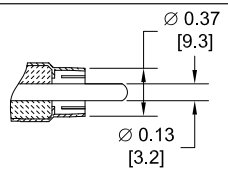
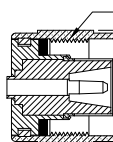
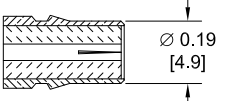
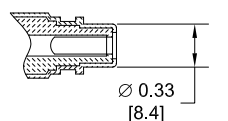
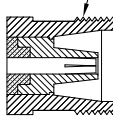
REVERSE POLARITY MCX	PLUG	 Ø 0.15" [3.7mm]	75 OHM MCX	PLUG	 Ø 0.15" [3.7mm]	MHV	MALE	 Ø 0.57" [14.5mm]
	JACK	 Ø 0.20" [5.0mm]		JACK	 Ø 0.20" [5.0mm]		FEMALE	 Ø 0.44" [11.1mm]
MINI 75 OHM SMB	PLUG	 Ø 0.25 [6.4]	MINI SMP	MALE	 Ø 0.11" [2.8]	MINI-UHF	MALE	 3/8-24 Ø 0.45 [11.5]
	JACK	 Ø 0.14 [3.7]		FEMALE	 Ø 0.09" [2.2]		FEMALE	 3/8-24 Ø 0.31 [7.8]
MMCX	PLUG	 Ø 0.09 [2.4]	N	MALE	 5/8-24 Ø 0.80 [20.3]	REVERSE POLARITY N	MALE	 5/8-24 Ø 0.80 [20.3]
	JACK	 Ø 0.14 [3.5]		FEMALE	 5/8-24 Ø 0.55 [14.0]		FEMALE	 5/8-24 Ø 0.55 [14.0]
75 OHM N	MALE	 5/8-24 Ø 0.80 [20.3]	PAL	PLUG	 Ø 0.38 [9.5]	POSITIVE SNAP	 Ø 0.39 [9.9]	
	FEMALE	 5/8-24 Ø 0.55 [14.0]		JACK	 Ø 0.37 [9.4]			
OMA	MALE	 Ø 0.41 [10.5]	RCA	PLUG	 Ø 0.37 [9.3] Ø 0.13 [3.2]	SC	MALE	 11/16-24 Ø 0.80 [20.3]
	FEMALE	 Ø 0.19 [4.9]		JACK	 Ø 0.33 [8.4]		FEMALE	 11/16-24 Ø 0.63 [15.9]

CONNECTOR IDENTIFIER

SPECIFICATIONS SHOWN ARE INTENDED FOR IDENTIFICATION PURPOSES ONLY

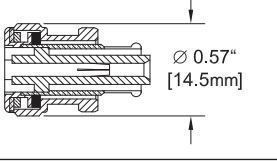
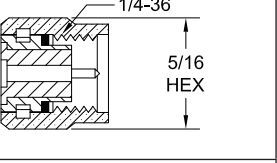
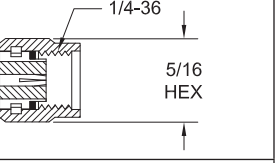
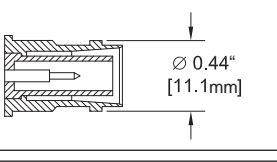
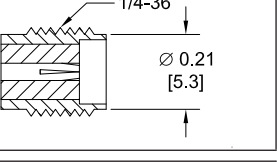
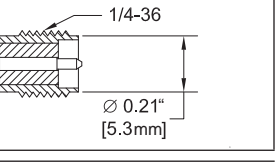
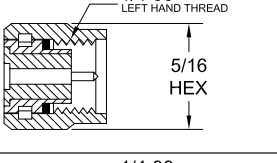
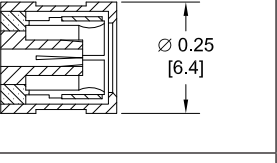
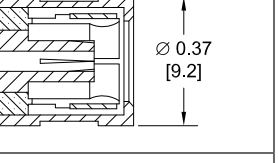
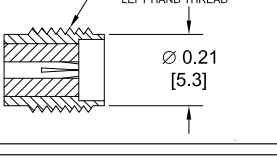
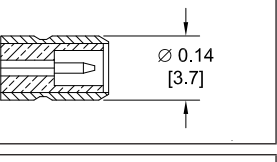
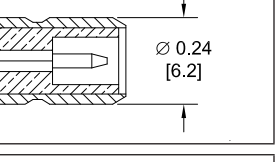
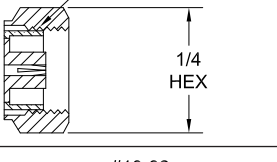
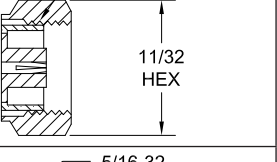
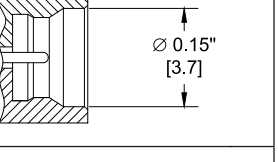
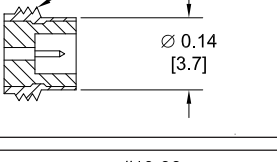
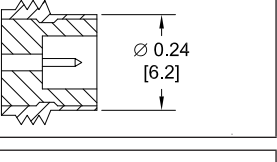
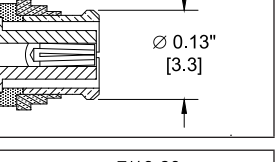
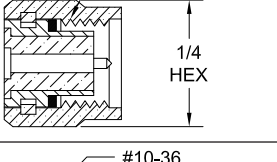
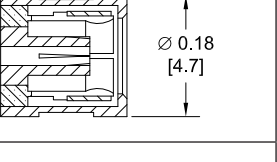
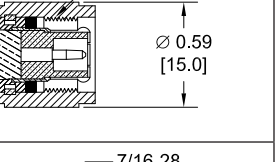
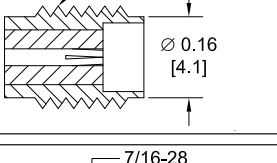
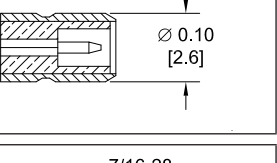
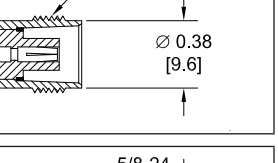
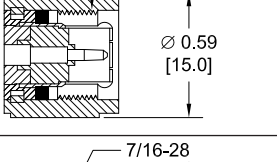
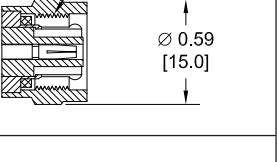
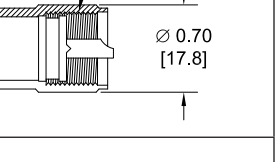
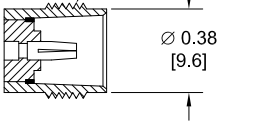
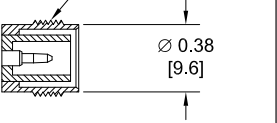
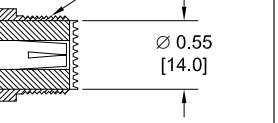
SHV	PLUG	 Ø 0.57" [14.5mm]	SMA*	MALE	 1/4-36 5/16 HEX	REVERSE POLARITY SMA	MALE	 1/4-36 5/16 HEX
	JACK	 Ø 0.44" [11.1mm]		FEMALE	 1/4-36 Ø 0.21 [5.3]		FEMALE	 1/4-36 Ø 0.21" [5.3mm]
SMA REVERSE THREAD	MALE	 1/4-36 LEFT HAND THREAD 5/16 HEX	SMB	PLUG	 Ø 0.25 [6.4]	75 OHM SMB	PLUG	 Ø 0.37 [9.2]
	FEMALE	 1/4-36 LEFT HAND THREAD Ø 0.21 [5.3]		JACK	 Ø 0.14 [3.7]		JACK	 Ø 0.24 [6.2]
SMC	PLUG	 #10-32 1/4 HEX	75 OHM SMC	PLUG	 5/16-32 11/32 HEX	SMP	MALE	 Ø 0.15" [3.7]
	JACK	 #10-32 Ø 0.14 [3.7]		JACK	 5/16-32 Ø 0.24 [6.2]		FEMALE	 Ø 0.13" [3.3]
SSMA	MALE	 #10-36 1/4 HEX	SSMB	PLUG	 Ø 0.18 [4.7]	TNC	MALE	 7/16-28 Ø 0.59 [15.0]
	FEMALE	 #10-36 Ø 0.16 [4.1]		JACK	 Ø 0.10 [2.6]		FEMALE	 7/16-28 Ø 0.38 [9.6]
75 OHM TNC	MALE	 7/16-28 Ø 0.59 [15.0]	REVERSE POLARITY TNC	MALE	 7/16-28 Ø 0.59 [15.0]	UHF	MALE	 5/8-24 Ø 0.70 [17.8]
	FEMALE	 7/16-28 Ø 0.38 [9.6]		FEMALE	 7/16-28 Ø 0.38 [9.6]		FEMALE	 5/8-24 Ø 0.55 [14.0]

*SMA, 2.92mm & 3.5mm CONNECTORS WILL MATE MECHANICALLY & ELECTRICALLY TO EACH OTHER.



Free Shipping Available
via UPS Ground to
USA & Canada



Technical
Support
(866) 727-8376



Same-Day Shipping,
Even Custom
Cable Assemblies

CONNECTOR FREQUENCY RANGE CHART

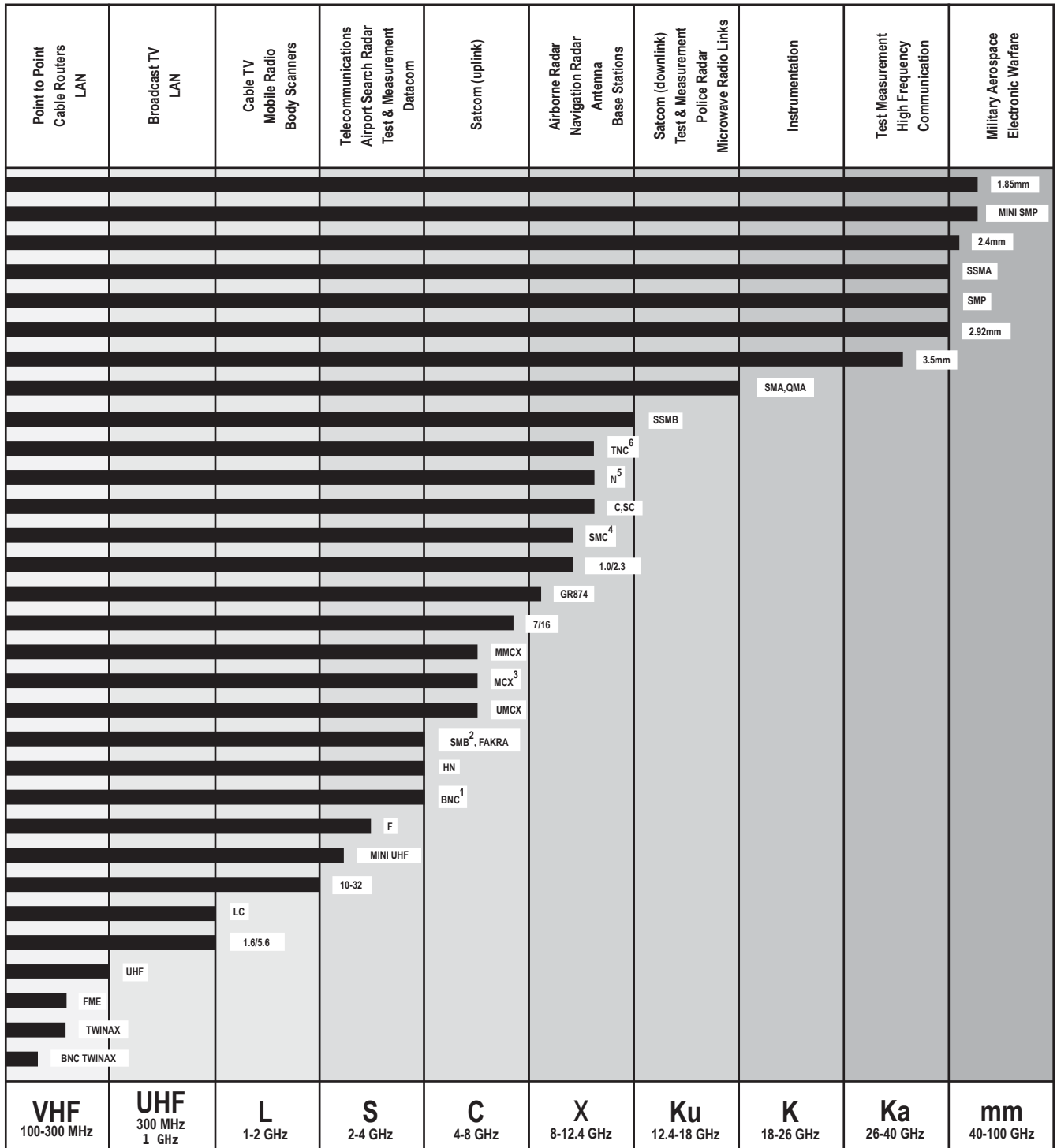

Notes:

- 1: BNC-75 Ohm connectors operate up to 1 GHz
- 2: SMB-75 Ohm & Mini SMB-75 Ohm connectors operate up to 4 GHz
- 3: MCX-75 Ohm connectors operate up to 6 GHz
- 4: SMC-75 Ohm connectors operate up to 10 GHz
- 5: N-75 Ohm connectors operate up to 1.5 GHz
- 6: TNC-75 Ohm connectors operate up to 1 GHz